

REWATEC

Solido Smart Sewage Treatment Plant

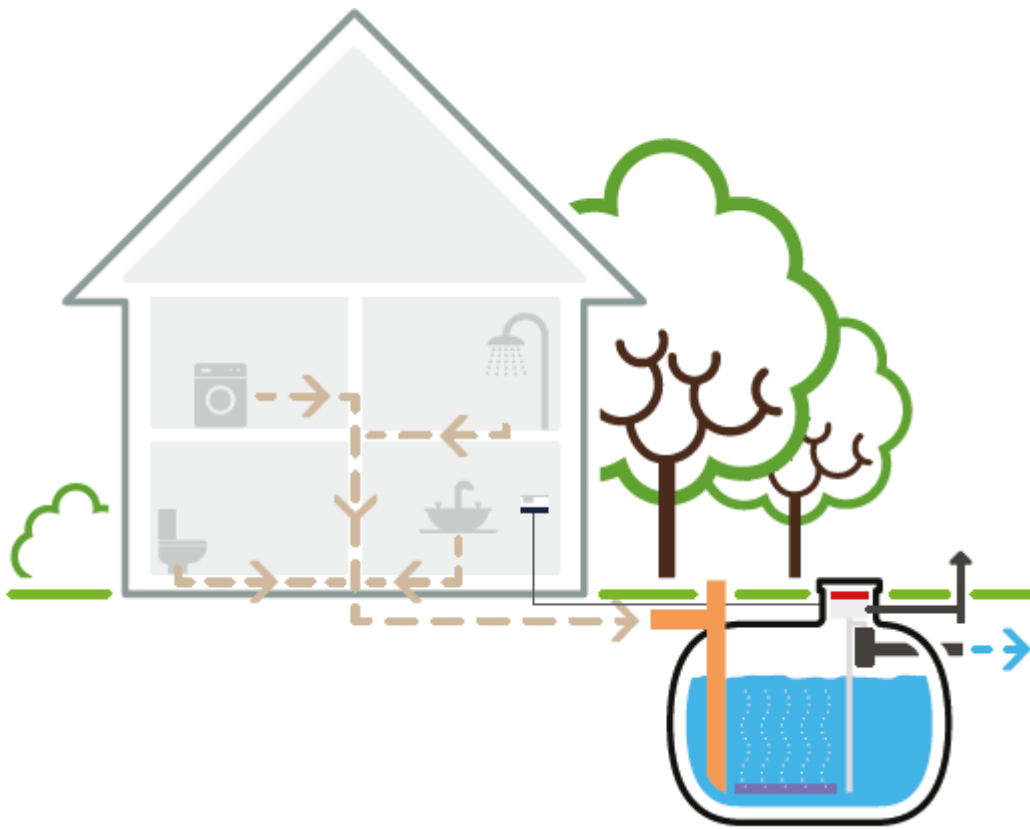

3000L & 4000L

Installation & Servicing Guide

Rewatec Solido Smart – 3000L & 4000L Single-Chamber Biological Nutrient Removal Sewage Treatment Plant

Manual Version

OM0047 Rewatec Solido Smart Rev 1 IRE

For Plants Manufactured on or After: 29 November 2021



Please Ensure You Are Using The

[Latest Solido Smart Installation Manual](#)



QR

Downloadable from <https://www.premiertechaqua.com/en-ie/wastewater-treatment/sequencing-batch-reactor-sbr#documents->

 This manual is designed for use by experienced sewage treatment tank installers & service providers.

- Premier Tech are proud to warrant the workmanship and components of the tank for the time period shown in this manual.
- Installers, commissioning agents and service providers must ensure they adhere to the installation guidelines and allow for site specific environmental conditions.



PT Water and
Environment Ireland

+353 (0) 22 51411

sales.ptwe.ie@premiertech.com

Premiertechaqua.com/en-ie

Property Owners Name:

Property Address:

City:

County:

Eircode:

Tel:

Installation Agents Name:

Installation Agents Address:

City:

County:

Eircode:

Tel:

Date Installation Carried Out:

TANK MODEL:

TANK SERIAL NUMBER:

This document constitutes guidance only – it is the responsibility of the installing agent to ensure the wastewater treatment plant is installed correctly, fully functional & operating as intended. For assistance please contact Premier Tech Water & Environment +353 (0) 22 51411 / sales.ptwe.ie@premiertech.com

- 1 [Health & Safety](#)
- 2 [Rewatec Solido Smart Overview](#)
- 3 [Tank Handling](#)
- 4 [Offloading Inspection](#)
- 5 [Assessing Ground Conditions](#)
- 6 [Locating Tank & Hole Excavation](#)
- 7 [Backfilling](#)
- 8 [Connections & Assembly Process](#)
- 9 [Control Panel Guide](#)
- 10 [Start-Up & Commissioning Procedure](#)

- [Servicing & Maintenance Guide](#)
- [Sludge Removal](#)



Hyperlinked Document

1. Health & Safety

You must read these warnings carefully before installing or using the equipment. Should the equipment be transferred to a new owner, always ensure that all relevant documents are supplied.

Observe all hazard labels and take appropriate action to avoid exposure to the risks indicated.

Take care to maintain correct posture, particularly when lifting. Use appropriate lifting equipment when necessary.



- Only experienced contractors should carry out installation, following the guidelines.
- The unit should have a Pre-Service Agreement Inspection by a competent engineer.
- A qualified electrician should carry out electrical work.
- Covers must be kept locked.
- Observe all hazard labels and take appropriate action to avoid exposure to the risks indicated.

Clothing

- We recommend the use of a dust mask and gloves when cutting components.
- Any person carrying out maintenance on the equipment should wear suitable protective clothing, including gloves.

Working Area

- Ensure that the working area is adequately lit.
- Ensure that you are familiar with safe working areas and accesses.
- Use only the designated access walkways. Do not walk on the cover or deep well safety mesh(es).
- Ensure proper footing and balance at all times.
- Avoid any sharp edges.

Desludging

- Desludging should be carried out by a licensed waste disposal contractor holding the relevant permits to transport and dispose of sewage sludge.
- The contractor must refer to the desludge instructions in the Operating Handbook, a copy of the instructions is fastened under the covers.

Maintenance and Inspection Procedures

- Should you wish to inspect the operation of the equipment, please observe all necessary precautions, including those listed below, which apply to maintenance procedures.
- The power supply to the equipment must be isolated at the control panel(s) before lifting the covers.
- If the equipment has to run with the covers off, all care must be taken to avoid contact with moving parts and electrical components or conductors.
- Drive guards must be replaced and secured if removed during maintenance.
- Once power has been isolated, the control panel must be kept locked shut to avoid accidental re-connection whilst work or inspection is being carried out.

Disclaimer: This document constitutes installation and inspection guidance only – it is the responsibility of the installation company to ensure the wastewater treatment plant is fully functional & operating as intended.

2. Rewatec Solido SMART Overview



SPECIFICATIONS

| Hydraulic capacity | Up to 1.2 m ³ /d | Up to 1.5 m ³ /d |
|-------------------------|-----------------------------|-----------------------------|
| Tank volume | 3 m ³ | 4 m ³ |
| Length | A 2.42 m | 2.47 m |
| Width | B 1.47 m | 1.66 m |
| Height | C 1.83 m | 2.23 m |
| Inlet height from base | D 1.34 m | 1.48 m |
| Outlet height from base | E 1.32 m | 1.43 m |
| Pipe diameter | 100 mm | |
| Access diameter | 600 mm | |
| Weight | 150 kg | 185 kg |

| | Efficiency | Effluent |
|--------------------|------------|----------|
| COD | 95.1% | 39 mg/l |
| BOD ₅ | 98.5% | 5 mg/l |
| SS | 97.1% | 13 mg/l |
| NH ₄ -N | 98.0% | 0.7 mg/l |
| N _{tot} | 83.1% | 10 mg/l |
| P _{tot} | 68.5% | 2.3 mg/l |



Shell Warranty – 25 Years*
 Technology & Pump Warranty – 3 Years*
 Design Life – 50 Years*

*Only when regular servicing schedule adhered to.

3. Tank Handling

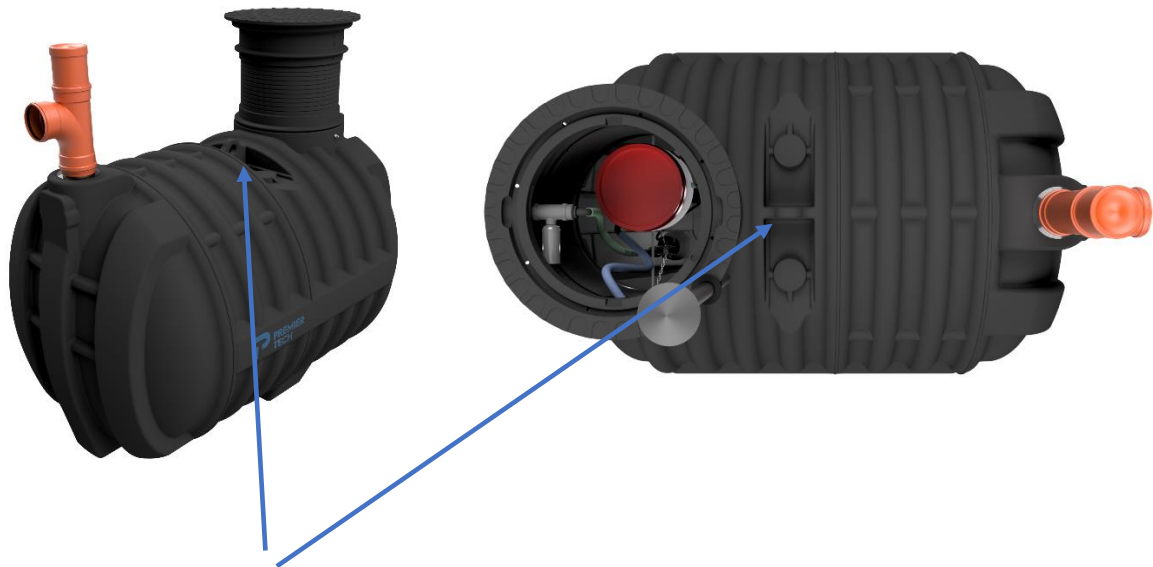

- Use lifting point only.
- Connect a webbed sling to the lifting point. (Do NOT use any other item such as rope or chain)
- Lift using a suitable mechanical device such as a crane or digger.
- Take care not to damage the tank



4. Offloading Inspection

- Check tank for signs of transit damage.
- Manway & manway cover are present & correct.
- Inlet/de-sludge pipe is present & correct.
- Ensure capsule and control panel are present.
- Ensure vent shaft and hose is present.
- Pump, lifting chain, hose and outlet assembly. (where specified)
- Tube diffuser and hose.
- PVC capsule holding pipe. (pre-installed)
- Nuts, bolts, washers and other components supplied in bag.
- Any additional options ordered. (ie Beacon)

Gravity

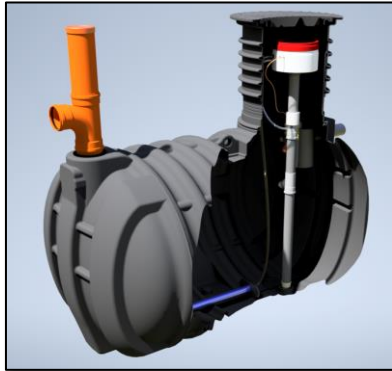

Pumped

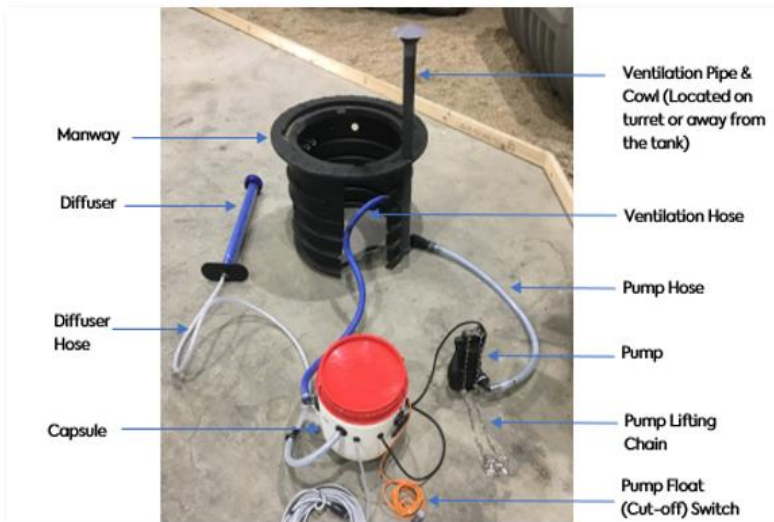
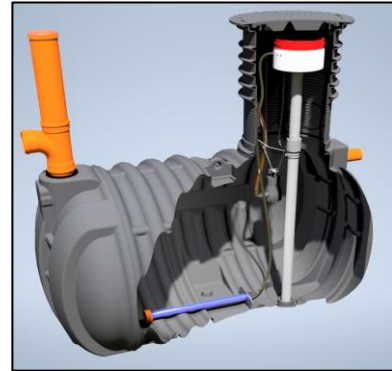

5. Assessing Ground Conditions

Ground conditions dictate whether the tank should be installed in pea gravel or concrete. A high-water table requires concrete installation, a low water table requires pea gravel installation.

Incorrect assessment of ground conditions can negatively impact the installation. Please ensure you read the below information.

Changing weather patterns in Ireland mean that regions or areas that may have been relatively dry, may now be subjected to heavy and sporadic rainfall events.

Signs of a High-Water Table

- Low permeability in soil (i.e., high clay content)
- Visible water table during excavation of the hole
- Naturally wet area
- Low lying or flat land
- Installation in a natural depression of the land
- Areas of low drainage or standing water
- Areas where water could congregate even if the land is currently dry

Signs of a Low-Water Table

- Absence of water during excavation
- When installing on a hilltop or hillside location
- Dry excavation even during wet weather
- High permeability soil

Installation in Periodic High-Water Table Conditions

If the ground water table could be above the turret (shoulder of the tank) height of the tank for a short period of time (defined as hours rather than days) a watertight connection between the tank and shaft system should be installed using a factory-provided welded joint (if considered necessary).

In such conditions, installation in concrete is recommended.

Installation in Permanently Low-Water Table Conditions

The water table below the turret (shoulder of the tank). Where the water table is below the turret of the tank, installation in pea gravel is recommended.

Installation in High-Water Table Conditions

If the water table is at risk of being higher than the turret (shoulder) of the tank for a prolonged period (defined as days rather than hours) installation in concrete is recommended.

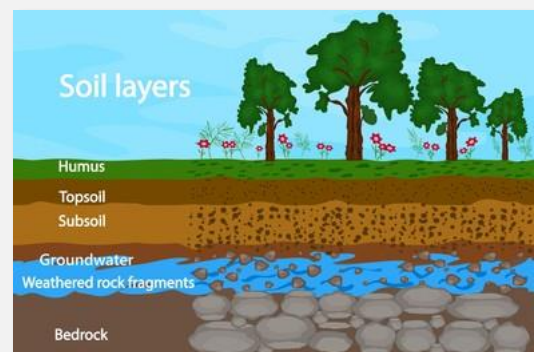

Hillside Situations

If the soil of the area is subjected to movement the tank will need to be secured with a supporting structure (e.g., a wall).

6. Locating the Tank & Hole Excavation

If you are in any doubt about any aspect of the installation, please contact Premier Tech.

Tank Positioning Next to Buildings

The excavation hole must be located a suitable distance away from buildings.

For tanks that are required to be located on driveways or where traffic is expected to pass a steel cover and a strengthened manway is required. Available from Premier Tech as an option.



- Ensure there are no sub-surface obstacles such as pipes, cables or tree roots.
- Ensure depth is sufficient for the tank to be located plus there is sufficient space for surface top-soil.
- Ensure the space between the tank and the edges of the excavated hole are at least 250mm.
- Ensure the tank height and positioning is such that the influent pipe runs downwards towards the tank from the property and the effluent discharge pipe runs in the desired direction towards the discharge point.
- Place a layer of gravel on the base of the excavated hole.
- Ensure the tank is perfectly flat in the ground using a spirit level.



- The soil coverage required above the tank (standard max. 1,50 meter, depend also on the traffic loads). The soil coverage should not be more than 1.2m from the top of the tank (1.5 from the IL), otherwise maintenance of the sewage treatment systems cannot not be carried out.

7. Backfilling

BACKFILLING PROCESS



After ensuring the tank is correctly positioned and perfectly flat in a bed of gravel.

- Fill the tank with water up to approximately 300mm then backfill to the same height with pea gravel or concrete depending upon your ground water conditions. (SEE BELOW FOR DETAILS ON WHEN TO USE PEA GRAVEL OR CONCRETE)
- Add 300mm more water then backfill again to approximately the same level as the water.
- Repeat this process until tank is completely backfilled with water up to the level of the pump and pea gravel until the body of the tank is completely covered.
- Above this level, top-soil or excavated material can be used.

Failure to do this creates uneven interior/exterior loads and could damage the tank shell.

BACKFILLING MATERIALS – LOW WATER-TABLE – PEA GRAVEL



Use pea gravel when installing in low water-table conditions.

The filling material around the tank must be compactable, permeable, and free of sharp objects. Round Gravel – Grain size between 5-16 mm. (alternatively 12-16 mm or 8-12 mm).

Soil, clay or “filler sand” **do not** meet these criteria.

The backfill material should reach at least of 250mm between the tank and the edge of the excavated hole.

BACKFILLING MATERIALS – HIGH WATER-TABLE – CONCRETE



Use concrete when installing in high water-table conditions.

Ensure the tank is correctly positioned and perfectly flat in a bed of concrete. Use a spirit level to achieve this.

The thickness of the concrete should be at least 250mm between the tank and the excavated hole.

Fill the tank with 300mm of water, then backfill to the same height with concrete and repeat until the body of the tank is completely covered.

Failure to do this creates uneven interior/exterior loads and could damage the tank shell.

8. Connections & Assembly Process

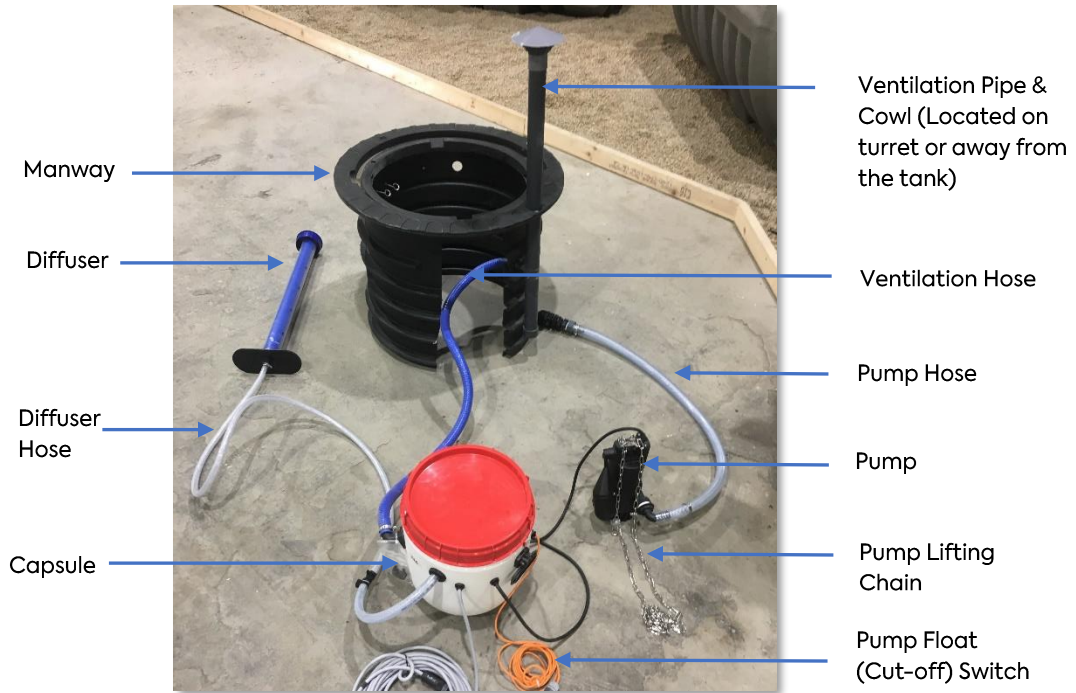

Overview

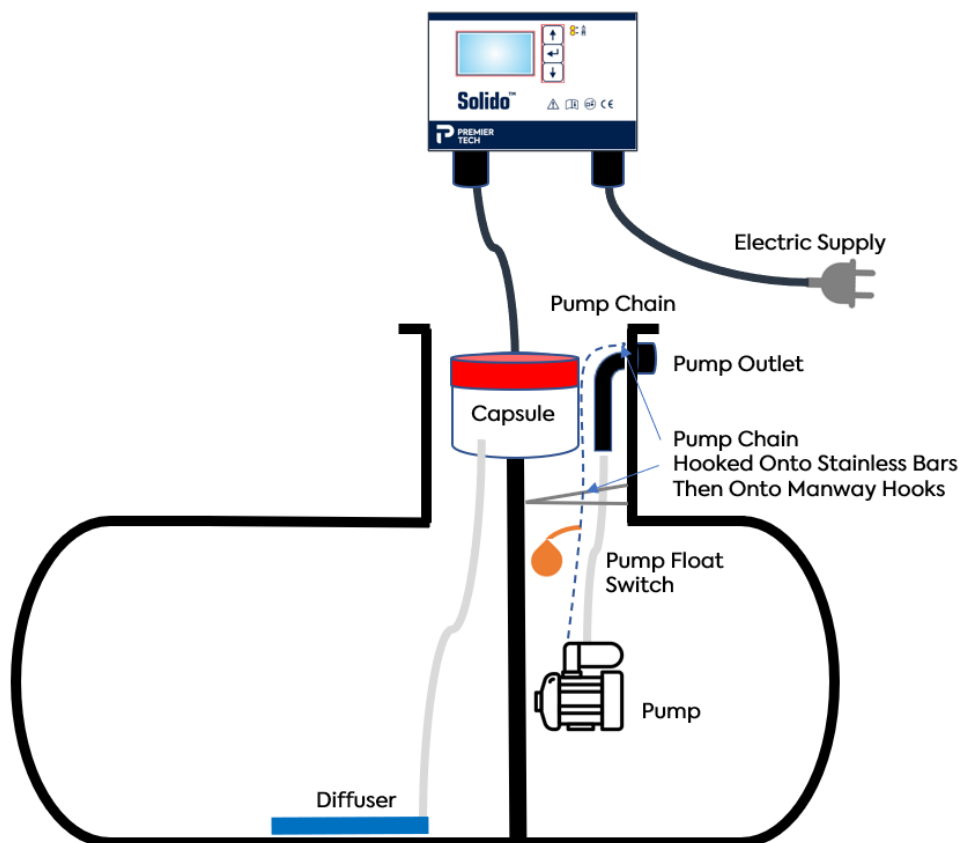

1. Positioning the Tank.

Ensure the tank height and positioning is such that the influent pipe runs downwards towards the tank from the property and the effluent discharge pipe runs in the desired direction towards the discharge point.

Ensure the discharge point will not be liable to flooding.

Add the extension pipe on top of the t-piece.

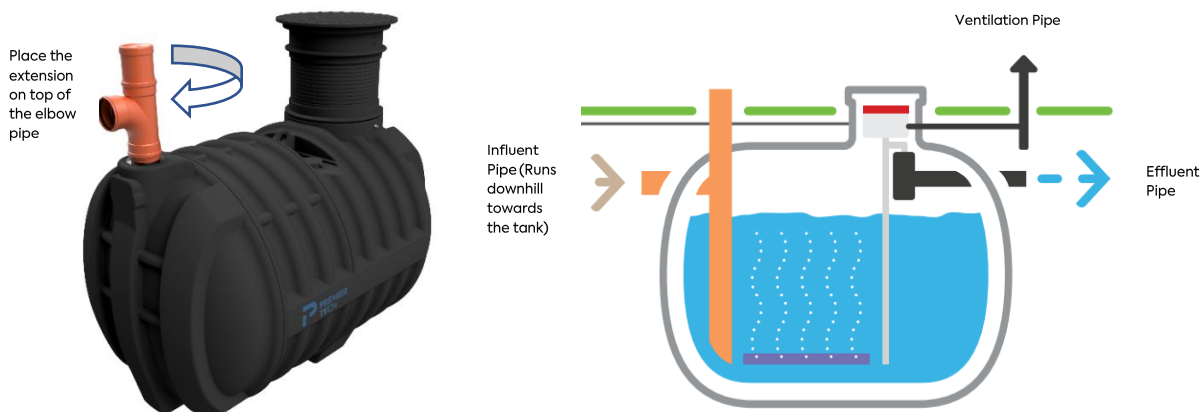

The de-sludge/inlet pipe can be rotated to suit the direction of the sewage inlet pipe.

2. The Tank Turret

Can be cut down on-site if necessary, to achieve the appropriate tank depth. Use the horizontal mould lines to assist with this.



Tool Required: Angle grinder/circular saw or similar.



3. Install the Capsule

Set the capsule onto the capsule holder PVC pipe. If a taller turret is being used for a deeper dig, install the capsule holder pipe extension and cut down to size if required.



Capsule



PVC Capsule Holder Pipe



Capsule Holder Extension Pipe
(Can be cut down if required)

4. Connections (Where not pre-fitted)

Attach the hose onto the lifter (Gravity version only)



Attach the hose onto the diffuser and the capsule – use jubilee clips where necessary

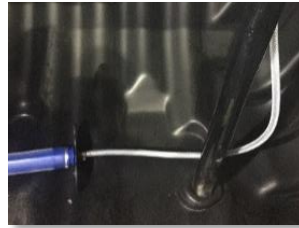

Place Diffuser Onto The Centre Of The Tank Floor

Connecting the pump outlet assembly. (If not assembled)



Connect One End of the Hose to The Pump



Install the connection on the other end of the hose

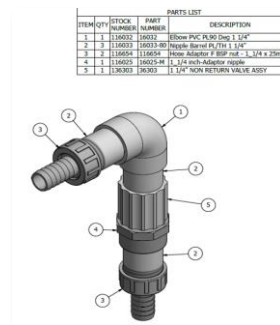

Cut hole in manway to position pump outlet pipe



Cut hole in manway to position pump outlet pipe

Ensure hose pipe is clipped into manway using clip provided. This provides support for the hose. Use bolts and washers to achieve this.

- Connect pump electrical cable to the capsule.
- Fit the capsule cable into the control panel.



Fit the control panel cable into the control panel.

Image for Demonstration Purposes Only – Connect Hoses In-Situ

5. Positioning Manway onto Turret



Position rubber seal onto turret – make sure the rubber ring is well-positioned in the groove of the manway. No major force is required if the rubber seal is positioned correctly into the groove



Position manway onto turret and press down until seal is created and manway is level

6. Drilling Manway Holes & Fitting Pipes/Cables (If required)

Tool Required: Circular cutter drill bits



The Drilling of Holes in the Manway is Required For:



Pump outlet hose & manway connection

Ensure there is a water-tight seal between the hose connections and the manway. The pump outlet hose assembly has integrated rubber seals to achieve this.



Ventilation pipe hose connection

Ensure there is a water-tight seal between the ventilation hose and the manway.



Electrical cable from capsule



NOTE – Ensure holes drilled into the turret for pipes and cabling are completely water-tight. If you have any questions regarding how to do this please contact premier tech.

NOTE – To ensure air hose pipes do not kink, cut down hose lengths where required. For example, if you have excess pipe from the pump to the pump hose outlet, cut the hose down in size to prevent kinking.



7. Pumped Version

Suspend the pump onto the threaded metal rods using the hooks located on the chain.

Attach the chain hooks into the turret as below. Position the hooks so they are easily accessible as high up in the turret as the chain length allows.



Pump hung on threaded bars



Hang chain onto hooks in manway to aid future access

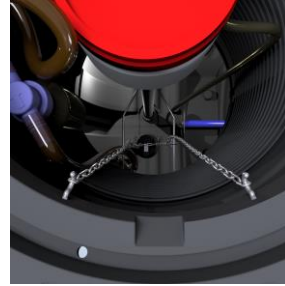

View of pump chains hung in manway

8. Fit Tank Cover

Position cover and turn locking nuts. Never leave the tank unattended without the cover in place.

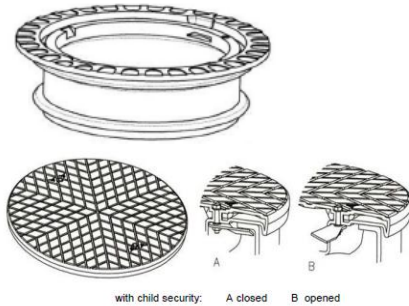

9. Connecting the Optional Flashing Beacon

Caution: Must have inverter fitted or connected to 12v power supply

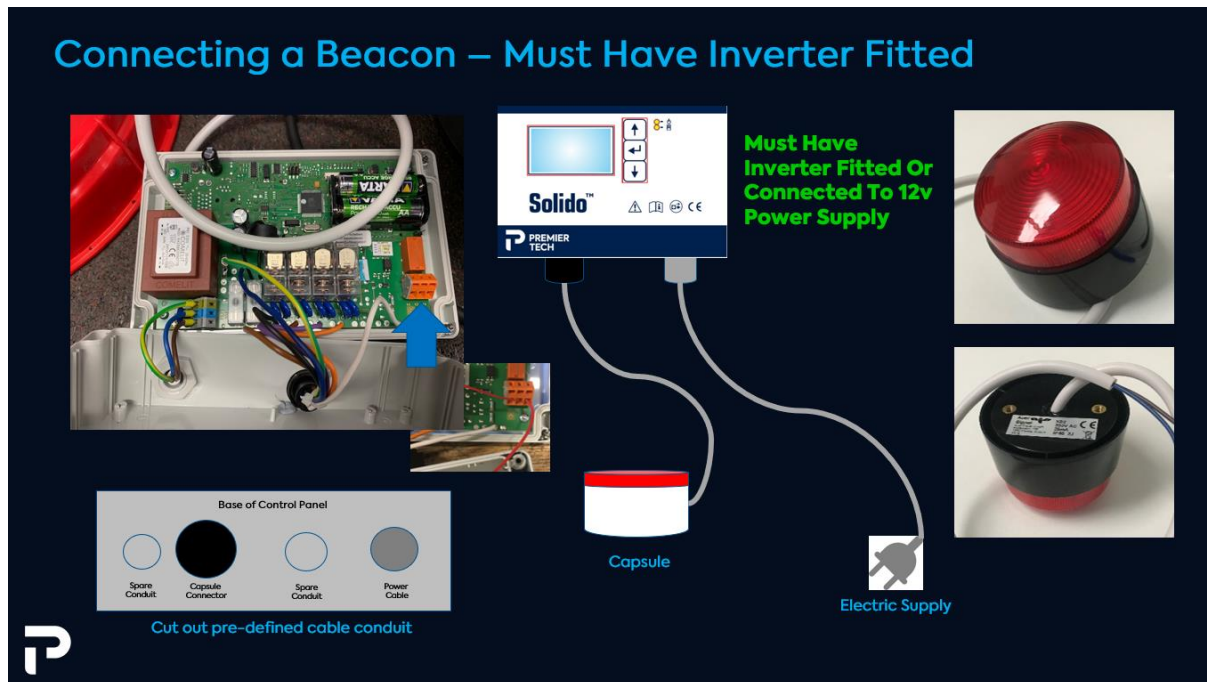

10. Connecting the Optional Sample Bottle

The optional sample bottle is fitted in-line between the pump effluent hose and the manway connection as below. Use jubilee clips to secure position.



11. Check the Complete Installation

Check the full installation:

- Tank location
- Ground conditions including inlet/outlet pipes
- Backfill is stable
- Control panel location is accessible
- Connections all completed
- Electric supply is reliable

12. Perform Start-Up

Once everything is connected, switch on the panel and configure the plant. Perform a test run to assess the electro-mechanical components.

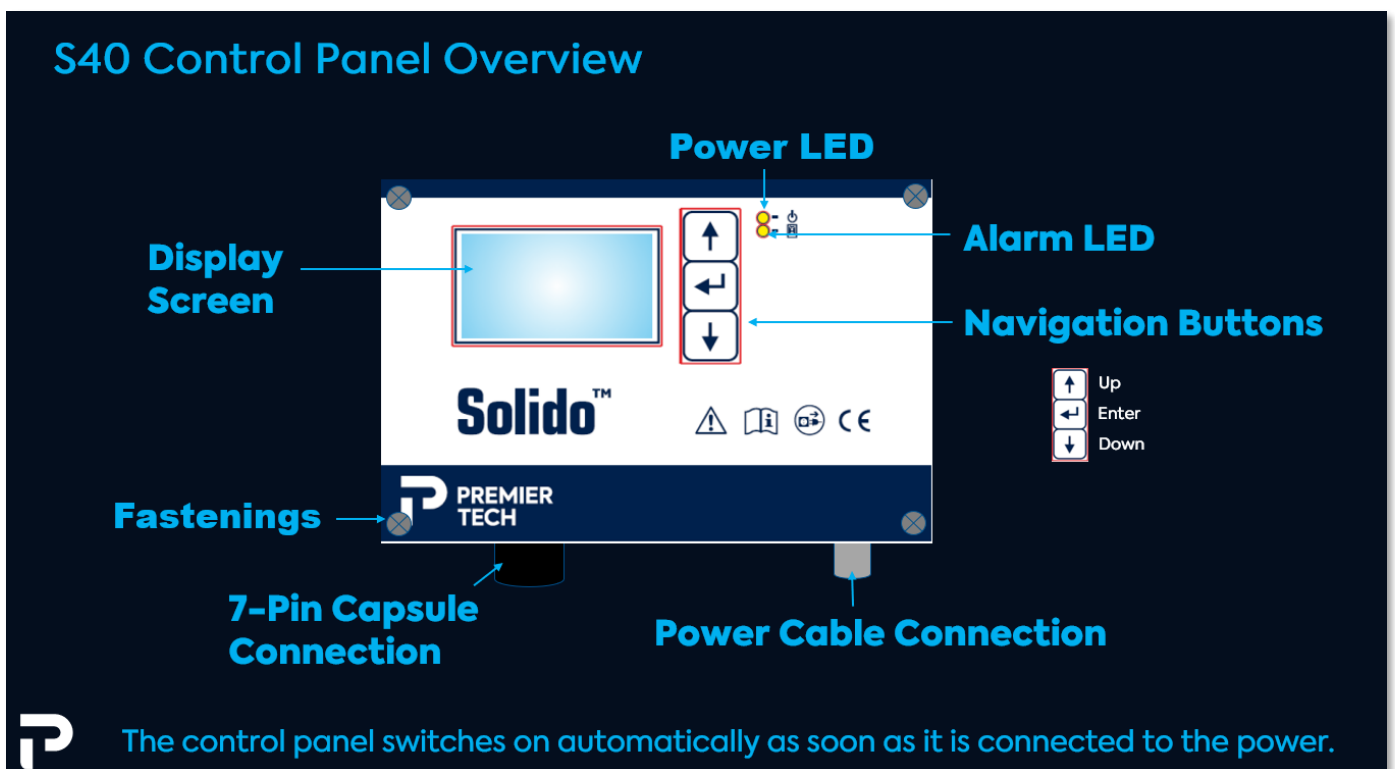

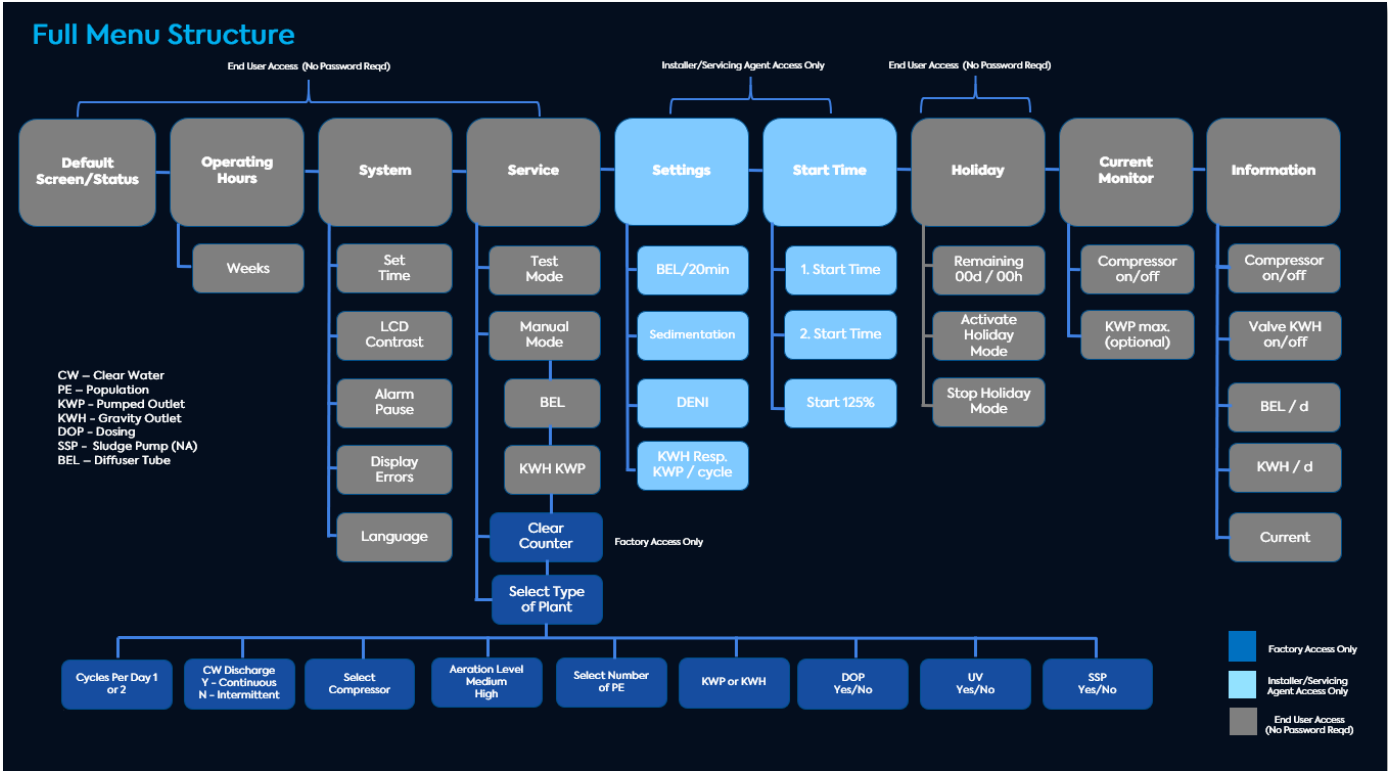

Control Panel Password

The control panel requires a code to access the system. This is a safety feature to discourage access by end users. Contact Premier Tech for the password.



The initial setup code is 7682 (First-time use only)



+353 (0) 22 51411

sales.ptwe.ie@premiertech.com

Premiertechaqua.com/en-ie



First Start Up (1/3)



- On first start up panel shows 'Sprache Deutsch'
- Press down to English – Press Enter.
- Set date and time using up down and enter.
- Enter Password 7682 using down and enter.
- Screen shows Solido Smart Yes press enter.
- Screen shows Cycles Per Day 2 press enter.

Full Menu Structure

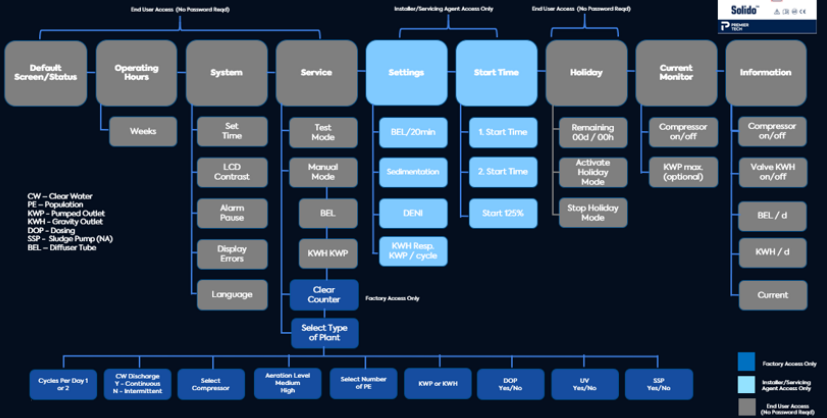

First Start Up (2/3)



- Screen shows Continuous CW Discharge Yes press enter (press NO only if you have a downstream process, i.e. slow infiltration bed, Ecoflo, reed bed or similar)
- Screen shows Select Compressor select correct option for your compressor type press enter.
- Screen shows Solido Smart C press enter.
- Screen shows Number of PE – using up and down select the number of persons in the property. Press enter.
- Screen shows KWP – Press enter for pumped outlet tanks. For gravity outlet tanks, it will show 'No', press enter.
- Where a pumped outlet tank is being installed – determine the distance from the tank to the effluent discharge. If the install requires pumped outlet more than 25m then access KWP and increase pumping time to 20 minutes.

Full Menu Structure

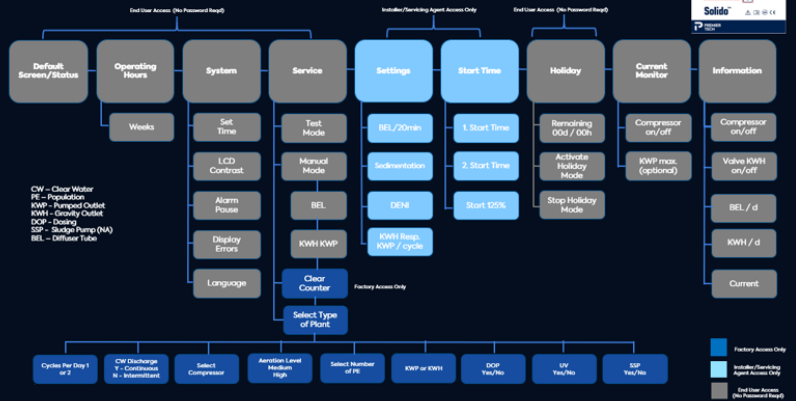

First Start Up (3/3)



- Up
- Enter
- Down

- Test mode will begin Do Not press any key if you want to run in test mode.
- It takes a few minutes to run the test mode depending upon the specification of tank.
- If the system runs without showing errors and does not alarm, then press the Enter Button.
- Screen shows 'Were inputs Ok' press down till Yes then press Enter. The system will start. (If No is entered the system will reboot to initial settings then reconfigure from the start).
- If you want to temporarily silence the alarm press the Enter once. If you press the Enter again the alarm will reset but will continue until fault is rectified.

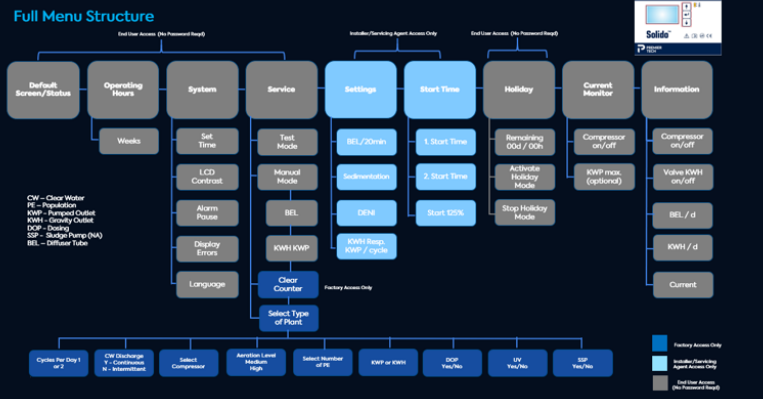

In some models, during setup, extra options may appear (depending on manufacturing data)

Aeration: Medium / High (press high)

DOP: Yes / No (Only press yes if installing a +P Phosphorus removal tank)

UV: Yes / No (press No)

SSP: Yes / No (press No)



Rebooting to Factory Settings



- Up
- Enter
- Down

- Navigate to **Clear Counter**
- Press Enter
- Contact Premier Tech for password and Enter
- Press Down until on the Start Time screen.
- Press Enter
- On Start Time screen press Down until on Reset - press Enter
- It will show Are You Sure press Down till shows Yes - press Enter
- System will reboot to factory settings.

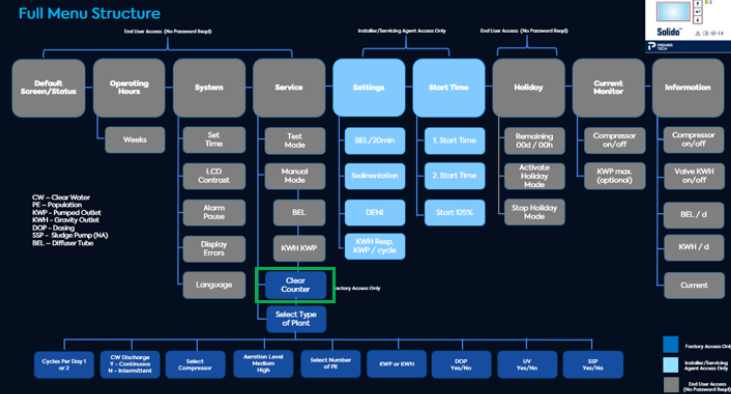

9. Start-Up & Commissioning Procedure

1. Is a 230 V power supply plug with a 30 mA residual-current circuit breaker available? Is the protective earth conductor functioning?
2. Is the treatment tank installed according to the installation manual?
3. Is the sludge removal pipe installed in accordance with the installation instructions including extension and cap?
4. Are the seals from the shaft assembly set for the air supply hose and cable conduit set in place? Is the cable holder installed? For pumped version, is the outlet installed?
5. Is the diffuser pipe installed in the centre of and horizontally on the tank floor?
6. Check the inlet pipe from the house is connected and the outlet pipe is connected to the downstream pipework.
7. Make sure ventilation is sufficient as described in this manual.
8. Fill the tank with clean water up to the level of the pump.
9. Ensure the pump is hanging both on the threaded stainless-steel rods as well as on the chain hooks positioned in the turret.

Servicing Guide for Professionals



Servicing & Maintenance



Ensuring the sewage treatment plant is regularly maintained is necessary to ensure the operational efficiency of the tank and to limit the possibility of any faults occurring.

■ Servicing

This should be conducted by a professional wastewater treatment servicing agent as a matter of course at least once a year. Failure to do this could impact the performance of the wastewater treatment plant and void the warranty.

Property Owners Name: _____

Property Address: _____

City: _____ County: _____ Eircode: _____ Tel: _____

Servicing Agents Name: _____

Servicing Agents Address: _____

City: _____ County: _____ Eircode: _____ Tel: _____

Date Service Carried Out: _____

TANK TYPE: _____

This document constitutes inspection guidance only – it is the responsibility of the inspection company to ensure the wastewater treatment plant is fully functional & operating as intended.

- Checked (Adjusted Where Required)
- May Need Future Attention
- Requires Immediate Attention

| | | | | |
|--------------------------|--------------------------|--------------------------|----|---|
| <input type="checkbox"/> | <input type="checkbox"/> | <input type="checkbox"/> | 1 | Consult with customer to determine if any issues have arisen |
| <input type="checkbox"/> | <input type="checkbox"/> | <input type="checkbox"/> | 2 | Perform test mode using control panel to ensure system is operating correctly. Ensure test panel is guarded against weather. |
| <input type="checkbox"/> | <input type="checkbox"/> | <input type="checkbox"/> | 3 | Replace batteries in the control panel |
| <input type="checkbox"/> | <input type="checkbox"/> | <input type="checkbox"/> | 4 | Check air blower is operating, remove and inspect diaphragm – clean or replace if necessary. Ensure air lines are tight. |
| <input type="checkbox"/> | <input type="checkbox"/> | <input type="checkbox"/> | 5 | Measure pressure in diffuser airline using a pressure gauge. (See required pressures below) |
| <input type="checkbox"/> | <input type="checkbox"/> | <input type="checkbox"/> | 6 | De-sludge tank using de-sludge pipe. (See below for further information) |
| <input type="checkbox"/> | <input type="checkbox"/> | <input type="checkbox"/> | 7 | Remove diffuser and clean with soapy water and jet wash if possible – ensure diffuser creates turbulence |
| <input type="checkbox"/> | <input type="checkbox"/> | <input type="checkbox"/> | 8 | Remove pump and clean checking and removing any debris around the impellor. Ensure pump is isolated before work. |
| <input type="checkbox"/> | <input type="checkbox"/> | <input type="checkbox"/> | 9 | Ensure there are no kinks in hose pipes. |
| <input type="checkbox"/> | <input type="checkbox"/> | <input type="checkbox"/> | 10 | Obtain a sample of the final effluent and check results. (See below for further information) |
| <input type="checkbox"/> | <input type="checkbox"/> | <input type="checkbox"/> | 11 | Check vicinity for any visible signs of pollution. (streams, ditches etc) |
| <input type="checkbox"/> | <input type="checkbox"/> | <input type="checkbox"/> | 12 | Check effluent is soaking into ground. (if discharge into drainage field) |
| <input type="checkbox"/> | <input type="checkbox"/> | <input type="checkbox"/> | 13 | Check top surface of biozone area for grease balls, soap suds, foaming or non-biodegradable material. Remove and dispose of. |
| <input type="checkbox"/> | <input type="checkbox"/> | <input type="checkbox"/> | 14 | Check that no water or moisture is present in the blower housing. |
| <input type="checkbox"/> | <input type="checkbox"/> | <input type="checkbox"/> | 15 | Where fitted, ensure the free movement of the non-return valve fitted in the discharge pipe from the effluent discharge pump. |
| <input type="checkbox"/> | <input type="checkbox"/> | <input type="checkbox"/> | 16 | Where fitted, ensure there is no debris in the pump discharge chamber. |
| <input type="checkbox"/> | <input type="checkbox"/> | <input type="checkbox"/> | 17 | Check final effluent is clean. (no suspended particles or cloudiness) |
| <input type="checkbox"/> | <input type="checkbox"/> | <input type="checkbox"/> | 18 | Ensure all lids and covers are correctly secured before leaving site. |
| <input type="checkbox"/> | <input type="checkbox"/> | <input type="checkbox"/> | 19 | Complete service documentation – debrief customer. |

Comments

De-Sludging

The design of the de-sludge pipe ensures that at 10% of the volume of contents will stay inside the tank. This is required to ensure ongoing biological operation.

De-Sludge using the de-sludge pipe only

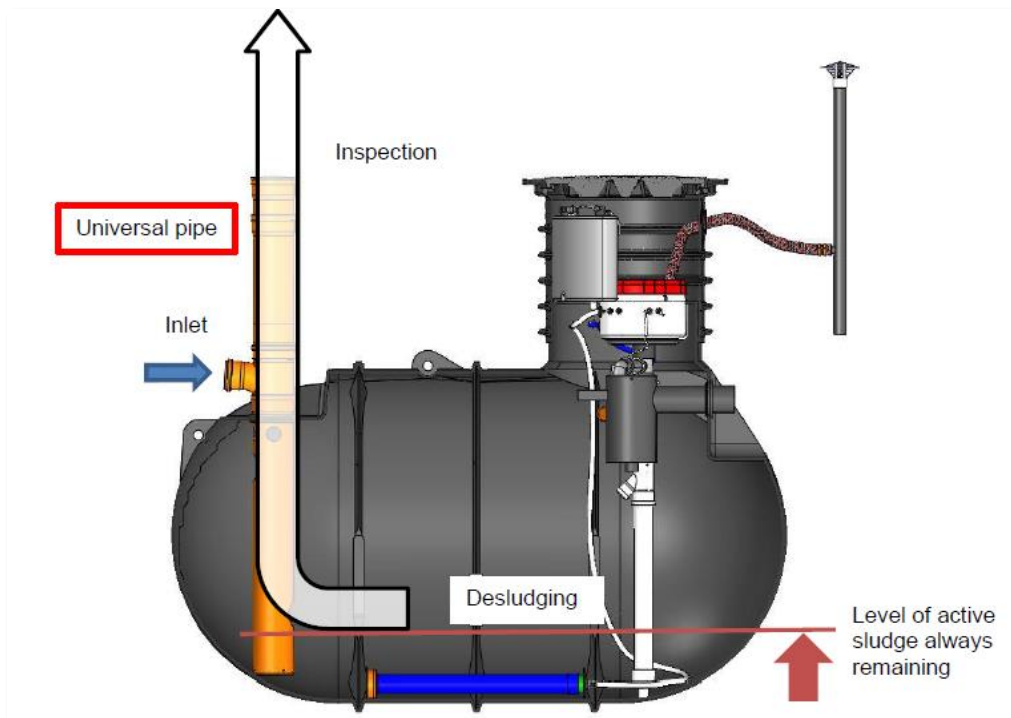

- Desludging is required if the sludge level reaches 70% of the max. permitted.
- If the sludge volume fraction is lower than that, then an annual desludging is the maximum acceptable period for solids' accumulation.
- Your service provider should carry out this test by using two volumetric cylinders, one empty and one half full of water.
- You must check whether the functions of the calmed inlet, aeration devices, and clearwater lifter are impacted by damaging substances (i.e fats, rags, inert solids). Substances that are damaging to functions should be removed each time that maintenance is performed.
- During desludging, you must ensure that airlift and aeration devices are not damaged, the plant is not in the middle of the sedimentation phase whenever possible, and that at least 10% of the sludge quantity remains in the container (inlet pipe has a corresponding opening to allow for the specific volume).

Pressure Build-Up At The Blower

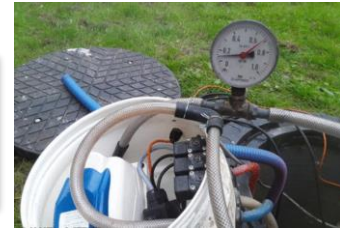
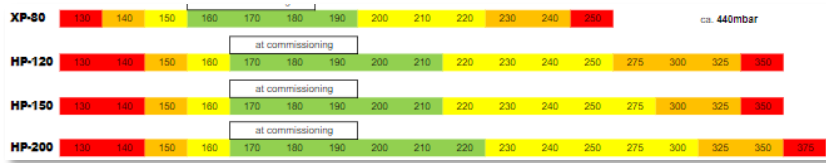

Sampling

Sampling and its verification according to the legal water usage permit In addition, sampling is to be performed and the following values are to be verified (the legal water usage permit is authoritative here):

- Temperature (if required)
- pH value (if required)
- TSS
- TN (if required)
- COD (if required)
- NH₄-N
- N-inert (if required)
- BOD₅
- TP (if required)



In SBR plants, effluent samples can be taken at any time from the sampling pot, which is installed in the discharge of the SBR chamber. For a pump version an independent sampling chamber can be installed downstream of the tank

Items Not Covered Under the Warranty

- Premier Tech Water & Environment accepts no liability for any damage or loss, including consequential loss, caused by the failure of any equipment supplied and shall not be liable for any labour involved for the removal or replacement of its equipment or the subsequent transportation, handling or packaging of any part or parts thereof.
- In no case will Premier Tech Water & Environment be liable for loss incurred because of interruption of service or for consequential damages, labour or expense required to repair defective units, nor shall this constitute a cause for the cancellation of the contract of purchase and sale.
- Specifically exempt from this warranty are limited life of consumable components subject to normal wear and tear, such as air pump vanes, diaphragms and filters.

Service charges will be incurred (including parts and labour), where the following has occurred:

- Failure to follow installation instructions or failure to follow operating and maintenance procedures.
- Accidental damage caused outside of Premier Tech's control.
- Unauthorised alterations made to the treatment plant.
- Improper use.
- Tampering.



TREATMENT PERFORMANCE RESULTS

Premier Tech Water and Environment Ltd.
Quartermown Industrial Estate, Mallow, Co. Cork, Ireland

EN 12566-3

Results corresponding to EN 12566-3 and S.R. 66

PIA-SR66-2103-1016

Rewatec Solido Smart

One-chamber SBR system in one PE tank

| Nominal organic daily load | 0.30 kg/d | | | | | | | | | | | | | | | |
|---|---|----------|------------|----------|-----|--------|---------|------------------|--------|--------|--------------------|--------|----------|----|--------|---------|
| Nominal hydraulic daily load | 0.90 m ³ /d | | | | | | | | | | | | | | | |
| Material | Polyethylene | | | | | | | | | | | | | | | |
| Watertightness | Pass | | | | | | | | | | | | | | | |
| Structural behaviour (Pit Test) | Pass (also wet conditions) | | | | | | | | | | | | | | | |
| Durability | Pass | | | | | | | | | | | | | | | |
| Treatment efficiency (nominal sequences) | <table><thead><tr><th></th><th>Efficiency</th><th>Effluent</th></tr></thead><tbody><tr><td>COD</td><td>95.1 %</td><td>39 mg/l</td></tr><tr><td>BOD₅</td><td>98.5 %</td><td>5 mg/l</td></tr><tr><td>NH₄-N</td><td>98.0 %</td><td>0.7 mg/l</td></tr><tr><td>SS</td><td>97.1 %</td><td>13 mg/l</td></tr></tbody></table> | | Efficiency | Effluent | COD | 95.1 % | 39 mg/l | BOD ₅ | 98.5 % | 5 mg/l | NH ₄ -N | 98.0 % | 0.7 mg/l | SS | 97.1 % | 13 mg/l |
| | Efficiency | Effluent | | | | | | | | | | | | | | |
| COD | 95.1 % | 39 mg/l | | | | | | | | | | | | | | |
| BOD ₅ | 98.5 % | 5 mg/l | | | | | | | | | | | | | | |
| NH ₄ -N | 98.0 % | 0.7 mg/l | | | | | | | | | | | | | | |
| SS | 97.1 % | 13 mg/l | | | | | | | | | | | | | | |
| Number of desludging | Not more than once | | | | | | | | | | | | | | | |
| Electrical consumption | 0.81 kWh/d | | | | | | | | | | | | | | | |

Performance tested by:

PIA – Prüfinstitut für Abwassertechnik GmbH
(PIA GmbH)
Hergenrather Weg 30
52074 Aachen, Germany

This document replaces neither the declaration
of performance nor the CE marking.



Notified Body
No.: 1739



Certified according to
ISO 9001:2015

PIA - Sustainable Certification
D. Schmitz
Le Wermter
Geprüft - tested - teste

Schmitz / Wermter

November 2021

